

THIS DOCUMENT IS THE PROPERTY OF RION TECHNOLOGY(SHENZHEN) LTD.(HEREAFTER"RION"),IT IS LENT AND IS TO BE RETURNED UPON REQUEST,THE CONTENTS OF THIS DOCUMENT ARE CONFIDENTIAL AND CONSTITUTE TRADE SECRETS PROPRIETARY TO RION,THIS DOCUMENT NOR ITS CONTENTS DOCUMENT NOR ITS CONTENTS SHALL BE DISCLOSED TO ANY UNAUTHORIAED PERSON COPIED OR PUBLISHED WITHOUT RION PRIOR WRITTEN CONSENT.
COPY RIGHT@2020 RION TECHNOLOGY

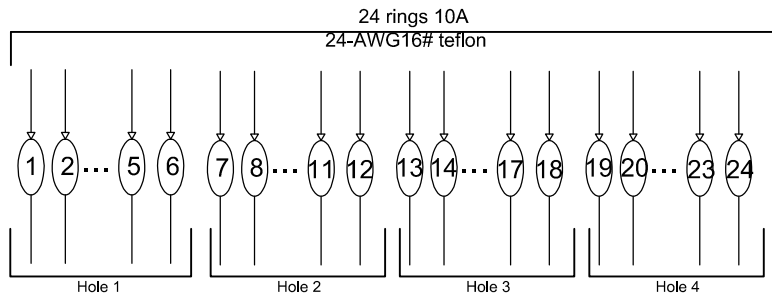
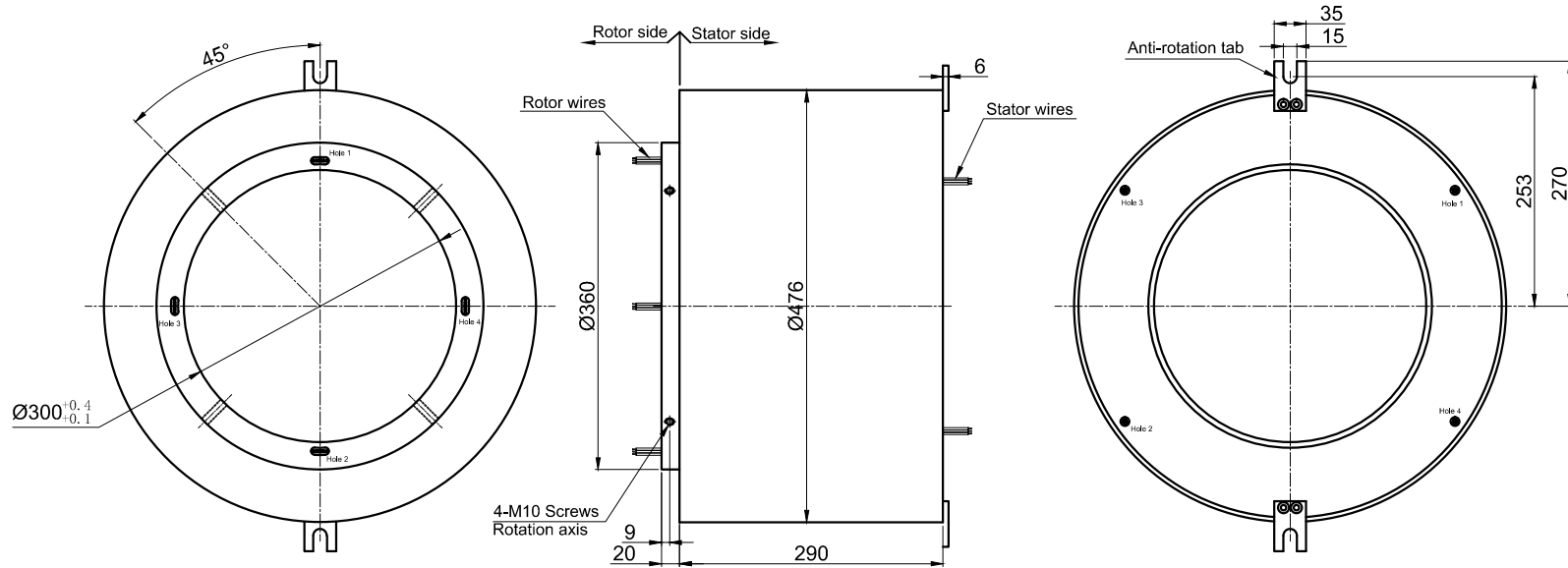

Electrical Specification

1 Rings	24	2 Current	Power module:24rings, 10A/ring
3 Voltage	0-440VDC/VAC		
4 Insulation Resistance	1000M Ω @1000VDC		
5 Electrical noise	Max.10m Ω ;		
6 Dielectric strength	1000VAC@50Hz;60S		

Mecchanical Specification

7 Speed	0~150RPM;	8 Torque	Max.0.8 N.M;
9 Life	Typical:10million revolutions, but strongly depends on your working conditions		

Environmental adaptability

10 Working temperature	-30 $^{\circ}$ C~+80 $^{\circ}$ C	11 Storage temperature	-35 $^{\circ}$ C~+85 $^{\circ}$ C
12 humidity	85 \pm 3%(30 $^{\circ}$ C+5 $^{\circ}$ C)		
13 Rush	40g,11ms,Half sine wave, Vertical direction 3 times,Level 3times		
14 IP Class	IP51		

Materral/Attachment

15 Contact Material	Precious metal	16 Housing material	ALL Alloy
17 Lead wire	Rotor:300mm(See wiring diagram) Stator:300mm(See wiring diagram)		

UNLESS OTHERWISE SPECIFIED		24 rings 10A	
1.ALL DIMENSIONS ARE IN MM HES BREAK SHARP EDGES &DEBURR		TOLERANCES (EXCEPT AS NOTED)	
2.MATERIAL&FINISH TO BE AS NOTED OR SUBSTITUTED WITH AN APPROVED AND TESTED EQUIVALENT		MODEL	RT300476-P2410
FILLET R.015	FINISH \checkmark	DECIMAL	X \pm .1 XX \pm .03 XXX \pm .005
THIRD ANGLE PROJECTION		SIZE	A
		R.E.V.	A/0
		SCALE	1:1
		UNIT	mm

